

Japanese Crests and Seals by Tara McGowan

Design Your Own! ↘

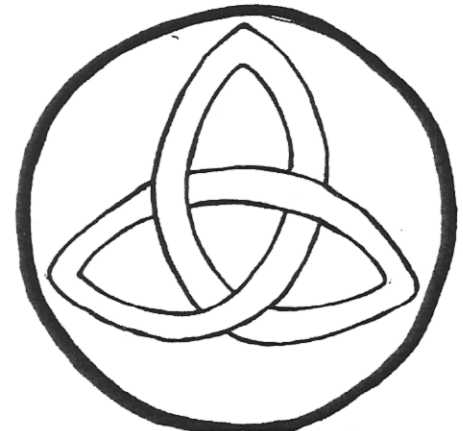

Hat

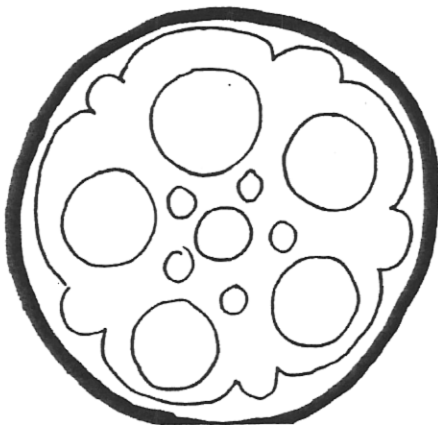
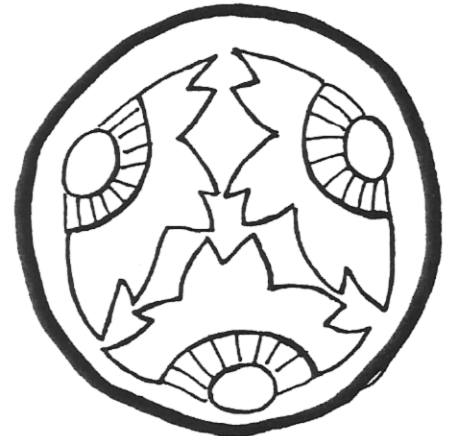
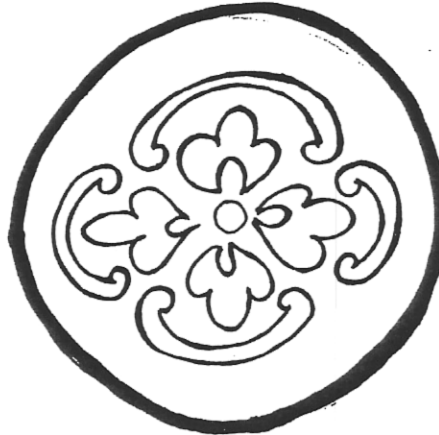
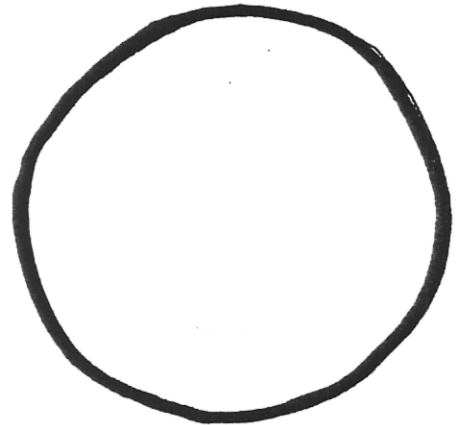
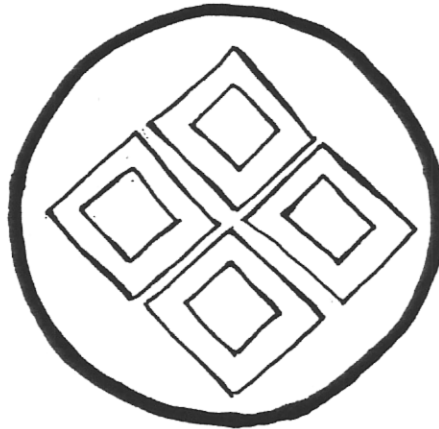
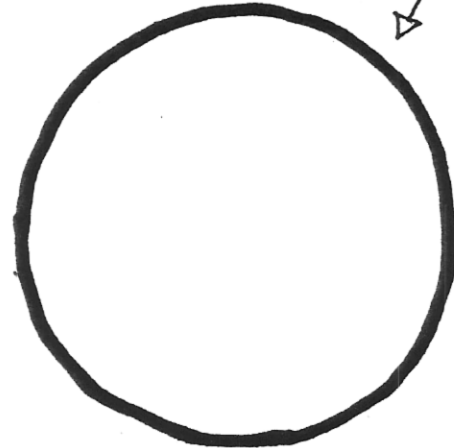
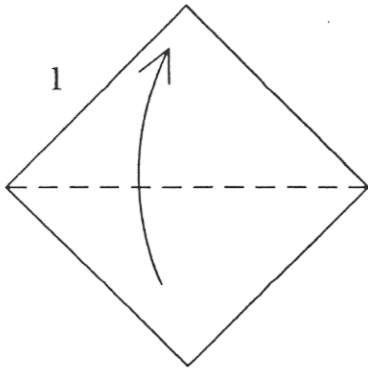

Fold in half.

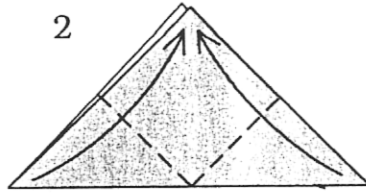

Fold the corners up.

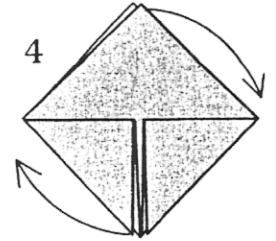
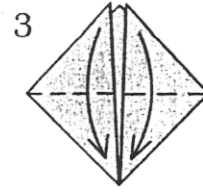

Rotate.

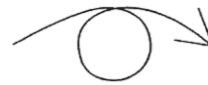
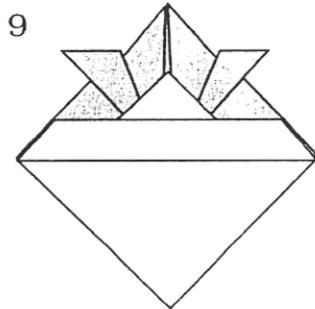
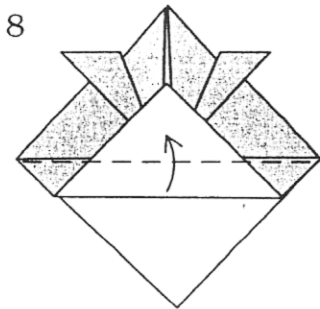
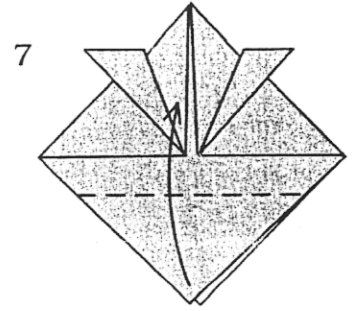
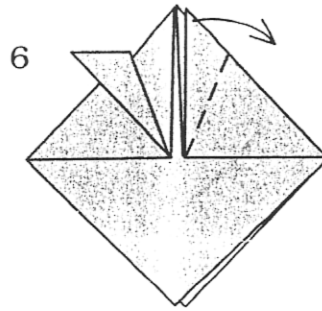
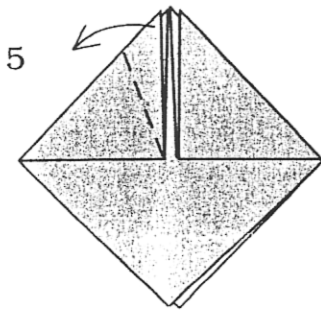

Turn over.

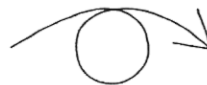
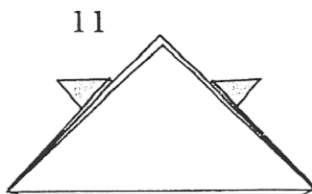
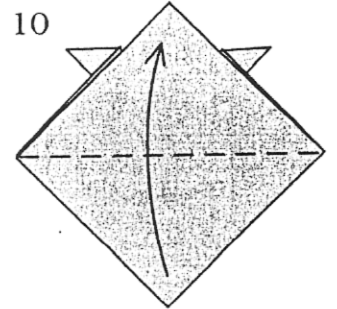

Turn over.

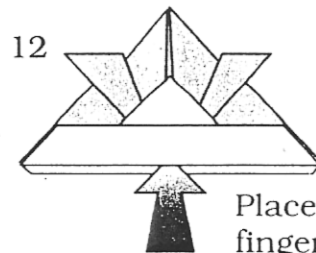

Place your finger inside to open the hat.

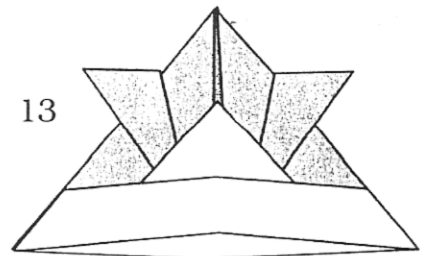

Hat